

METAL SLEEVE OR CERAMIC SLEEVE

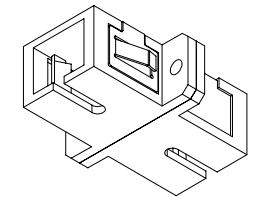

SPECIFICATION:
SC-SC ADAPTER
SIMPLEX, WITH METAL (CERAMIC) SLEEVE (PLASTIC HOUSING)

	MULTIMODE	SINGLEMODE
METAL SLEEVE (PLASTIC HOUSING)	PART NO. 53302.3 (13-2018M)	PART NO.
CERAMIC SLEEVE (PLASTIC HOUSING)	PART NO.	PART NO.
COLOR	BEIGE	BLUE

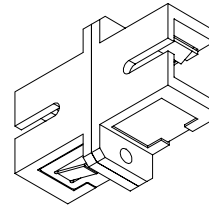
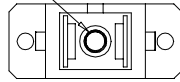
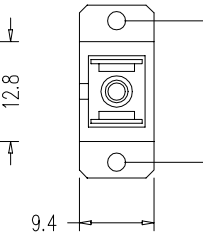
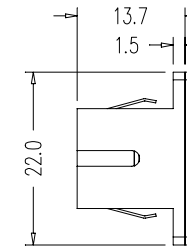
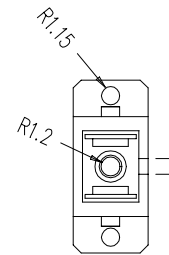
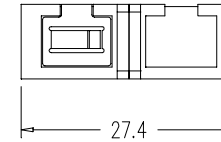

COLOR: BLACK

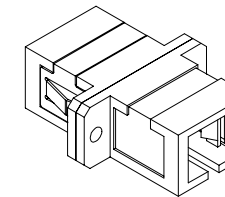
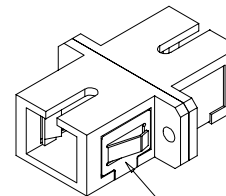
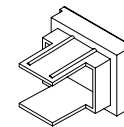
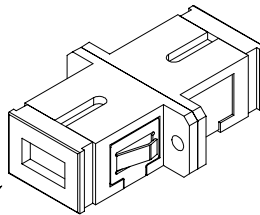

LATCH

DUST COVER
COLOR: BLACK

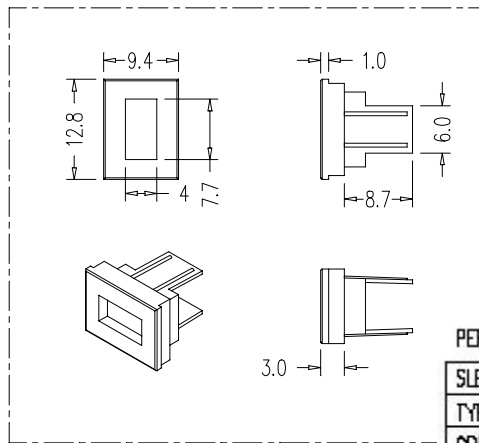
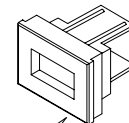

PERFORMANCE SPECIFICATIONS:

SLEEVE MATERIAL	CERAMIC	METAL
TYPICAL INSERTION LOSS, dB	≤ 0.3dB	≤ 0.3dB
OPERATION TEMPERATURE, °C	-40°C~+75°C	-40°C~+75°C
STORAGE TEMPERATURE, °C	-40°C~+85°C	-40°C~+85°C

	TITLE: FIBER OPTIC ADAPTER (SC-SC ADAPTER)		
	DATE:	MAR-08-2002	DESIGNED:
	DRAW NO.:	53302.3	APPROVED:
	SCALE:	1:1	ORDER NO.:
	UNIT: mm	REV:	1-0
		TOLERANCE:	±0.20