

Datenblatt

Bestell-Nr.: 13734

Anbausteckdose Quick-Connect gerade

Ampere	16A
Polzahl	3p (2P+PE)
Uhrzeitstellung	6h
Spannung	200 bis 250V
Frequenz	50 und 60Hz
Schutzart	IP67
Kennfarbe	blau RAL 5010
Anschlußtechnik	schraublose QUICK-CONNECT Anschlusstechnik
Kontaktträger	aus Polyamid, die Kontakte sind Messing blank
Gehäusematerial	Polyamid

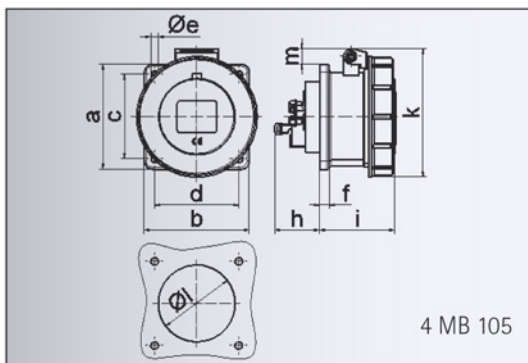

Ampere	16	16	16	32	32	32
Polzahl	3	4	5	3	4	5
a	75,0	75,0	75,0	75,0	75,0	75,0
b	75,0	75,0	75,0	75,0	75,0	75,0
c	60,0	60,0	60,0	60,0	60,0	60,0
d	60,0	60,0	60,0	60,0	60,0	60,0
e ø	5,5	5,5	5,5	5,5	5,5	5,5
f	7,0	7,0	7,0	8,0	8,0	8,0
h	35,5	35,5	35,5	50,0	50,0	50,0
i	57,0	58,0	57,0	65,0	65,0	65,0
k	76,0	83,0	93,0	100,0	100,0	106,0
l ø	45,0	45,0	55,0	60,0	60,0	60,0
m	3,5	7,0	11,5	12,0	12,0	17,0
Leiter mm ² min	1,5	1,5	1,5	2,5	2,5	2,5
Leiter mm ² max	4	4	4	10	10	10