

FLIR 200.2027.35/DALI

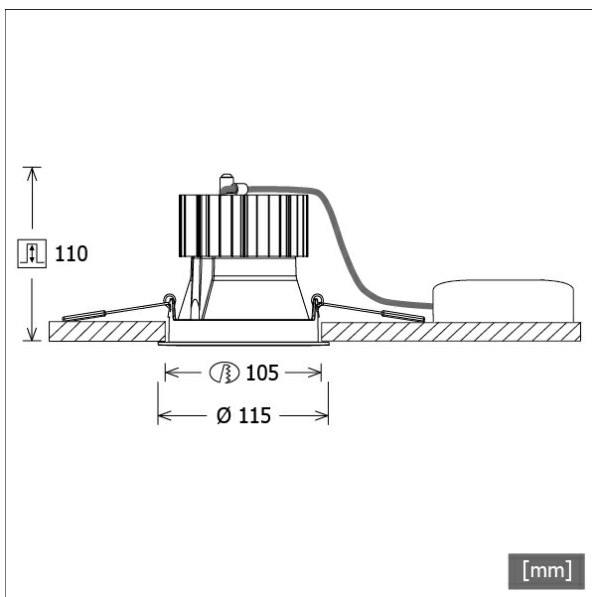

Farbe	Artikelnummer	EAN
schwarz	641741	4043544472878
silber	641742	4043544472885
weiß	641743	4043544472892



Beschreibung

- Einbaustrahler mit optischen Designvarianten und breitem Anwendungsspektrum
- Lichtkopf 20° schwenkbar
- hohe Wartungsfreundlichkeit
- keine UV- und Wärmestrahlung
- Wärmemanagement mit Passivkühlung (Kühlkörper aus Aluminiumdruckguss)
- High-Performance Spiegelreflektor aus Aluminium mit präziser symmetrischer Abstrahlcharakteristik für maximale Lichtausbeute und optimale Entblendung
- Front-/Einbauring aus Zinkdruckguss mit Lichteffektring klar (weitere Dekor-/Lichteffektringe und Dekogläser sind als Option erhältlich)
- werkzeugloser Deckeneinbau mit Schnellspannfedern (automatische Anpassung der Deckenstärke)
- Anschluss an Betriebsgerät über Leuchtenkabel mit Mini-Clamp Steckverbindung
- Betriebsgerät (LED-Konverter DALI, dimmbar) inklusive (Platzierung extern)

Standardoptionen

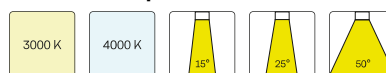

Sonderoptionen



Lichttechnik / Normen

Leuchtmittel	LED Spot / CRI 80 / 2700 K
EPREL Lichtquellen	848120
Lebensdauer	L90 B50 50.000 h L80 B50 100.000 h L80 B20 50.000 h
Systemleistung	27,0 W
Leuchten-Lichtstrom	max. 2810 lm
Systemeffizienz	104,07 lm/W
Moduleffizienz	127,18 lm/W
UGR Klasse	≤28
Abstrahlwinkel	35°
Versorgungsspannung	220 - 240 V / 50 - 60 Hz
Schutzklasse	III
Schutzart	IP20

Abmessungen / Gewichte

Außendurchmesser	115 mm
Höhe	112 mm
Ausschnittsmaß (∅)	105 mm
Deckenstärke	1,0 - 25,0 mm
Einbautiefe	110 mm
Nettogewicht	0,93 kg
Bruttogewicht	1,01 kg

FLIR 200.2027.35/DALI

Flixx 200 Round (FLIRZ 200.05, 1xLED 27W 827/2700K 2810lm 35 °)

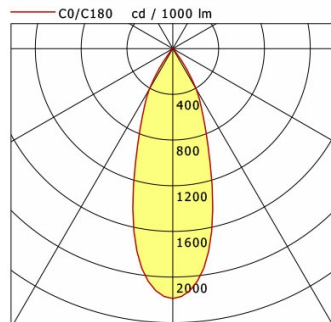

	C0	C90	C180	C270
0°	2188	2188	2188	2188
15°	1344	1344	1344	1344
30°	409	409	409	409
45°	18	18	18	18
60°	14	14	14	14
75°	6	6	6	6
90°	0	0	0	0

cd / 1000 lm

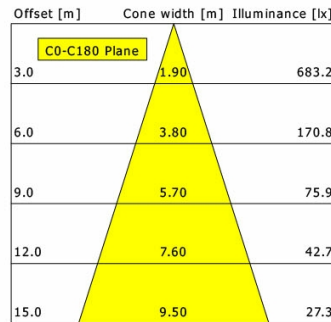

η	LED
Efficiency	104 lm/W
Direct/Indirect	↓ 100% / ↑ 0%
System Power	27 W
UGR	X=4H, Y=8H
Reflection factors	70/50/20
UGR C0/C180	20.4
UGR C90/C270	20.4
CIE Flux Codes	96 98 100 100 100
Ra/CRI	>80

LTS

Flixx 200 Round (FLIRZ 200.24, 1xLED 27W 827/2700K 2650lm 35 °)

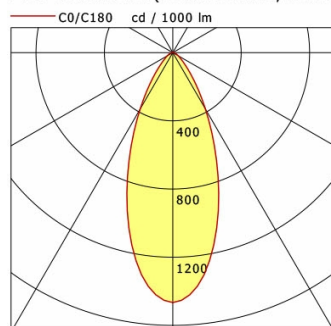

	C0	C90	C180	C270
0°	1466	1466	1466	1466
15°	1014	1014	1014	1014
30°	382	382	382	382
45°	104	104	104	104
60°	37	37	37	37
75°	15	15	15	15
90°	0	0	0	0

cd / 1000 lm

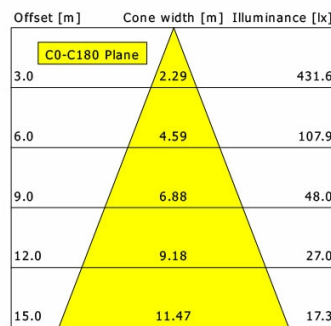

η	LED
Efficiency	98 lm/W
Direct/Indirect	↓ 100% / ↑ 0%
System Power	27 W
UGR	X=4H, Y=8H
Reflection factors	70/50/20
UGR C0/C180	25.9
UGR C90/C270	25.9
CIE Flux Codes	84 95 99 100 100
Ra/CRI	>80

LTS

Flixx 200 Round (FLIRZ 200.25, 1xLED 27W 827/2700K 2730lm 35 °)

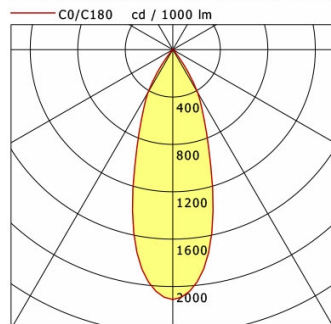

	C0	C90	C180	C270
0°	2110	2110	2110	2110
15°	1310	1310	1310	1310
30°	419	419	419	419
45°	21	21	21	21
60°	16	16	16	16
75°	5	5	5	5
90°	0	0	0	0

cd / 1000 lm

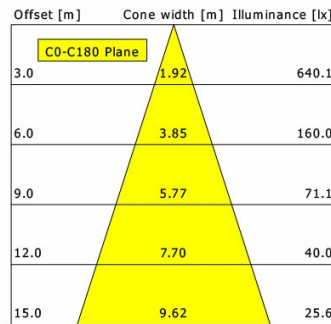

η	LED
Efficiency	101 lm/W
Direct/Indirect	↓ 100% / ↑ 0%
System Power	27 W
UGR	X=4H, Y=8H
Reflection factors	70/50/20
UGR C0/C180	20.6
UGR C90/C270	20.6
CIE Flux Codes	95 98 100 100 100
Ra/CRI	>80

LTS

FLIRZ 200.2027.35/DALI

Zubehör



FLIRZ 200.01
Dekorring schwarz



FLIRZ 200.02
Dekorring silber



FLIRZ 200.03
Dekorring weiß



FLIRZ 200.04
Lichtefferkring opal



FLIRZ 200.05
Lichtefferkring klar



FLIRZ 200.06
Lichtefferkring rot matt



FLIRZ 200.07
Lichtefferkring gelb matt



FLIRZ 200.08
Lichtefferkring blau matt



FLIRZ 200.16
Lichtefferkring rot transluzent



FLIRZ 200.17
Lichtefferkring gelb transluzent



FLIRZ 200.18
Lichtefferkring blau transluzent

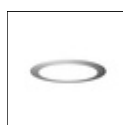

FLIRZ 200.24
Dekoglas opal



FLIRZ 200.25
Dekoglas klar



ZB-ORGR DONGLE
Organic Response IR-Dongle-Set



ZB-ORGR GATEWAY
Organic Response IoT-Gateway Kaskadenserie