

SCHALTBILDER

EZF 40/4 B

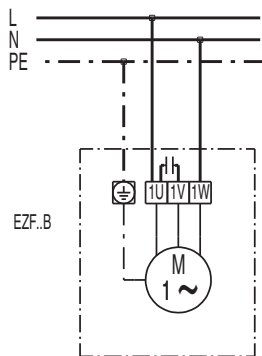
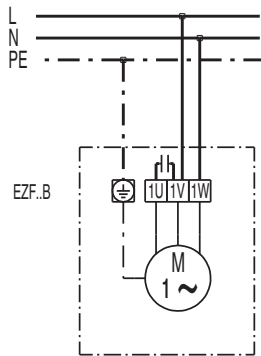

SCHALTBILDER

EZF 40/4 B

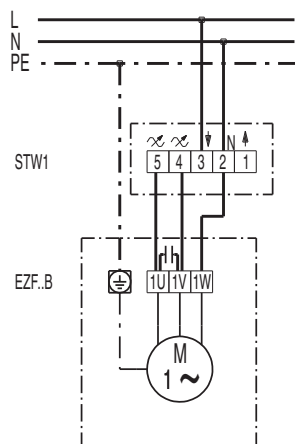
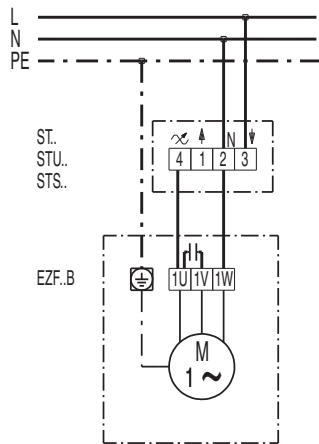

EZF 40/4 B

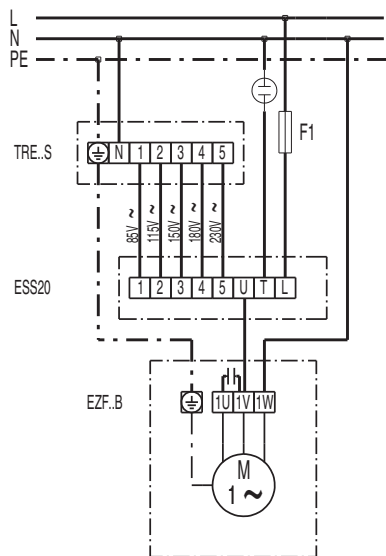
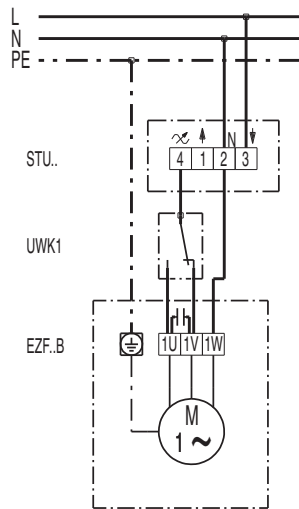

SCHALTBILDER

EZF 40/4 B

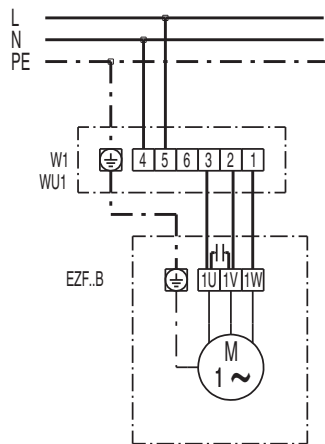
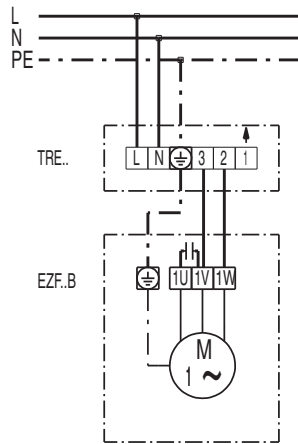

SCHALTBILDER

EZF 40/4 B

