

Panel mounting socket outlet angled - flange 87x71 fixing centers 70x52



Product description	
BALS-Prd.-Nr	12734
EAN	4024941127349
Product category	Panel mounting socket outlet QUICK-CONNECT, angled
Current	16A
Number of poles	4p
Arrangement of phases	3P+PE
Position of earth contact	9 h
Voltage	200 - 250V~

Product description	
Frequency	50/60Hz
Protection degree	IP44
Colour code	blue RAL 5015
Colour of appliance	Hinged lid blue RAL 5015, Enclosure grey RAL 7035
Connection design	screwless spring terminals with KONTEX-contact
Maximum conductor size	4,0 qmm
Cable entry	other
Height	90mm
Width	71mm
Depth	96mm
Flange size vertical in mm	87mm
Flange size horizontal in mm	71mm
Drill hole dist. vertical mm	70mm
Drill hole dist. horizontal mm	52mm
Material of enclosure	Polyamide
Contacts	the contact carrier is made of polyamide, the contacts are brass

Additional technical properties	
	The inclination is 20°

Logistics data	
Weight/pcs	0.121 kg / Piece
Packaging	Bag
Content amount	1 ST
EAN	4024941127349
Length	96 mm
Width	71 mm
Height	90 mm
Weight	0.122 kg
Volume	613.44 ccm
Packaging	Carton
Content amount	10 ST
EAN	4024941829250
Length	245 mm
Width	177 mm
Height	185 mm
Weight	1.343 kg
Volume	7,140 ccm

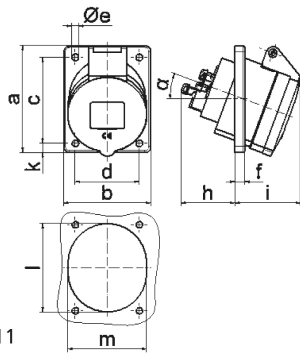

4 MB 111

Ampere	16	16	16			
Polzahl	3	4	5			
a	68,0	87,0	87,0			
b	62,0	71,0	71,0			
c	47,0	70,0	70,0			
d	47,0	52,0	52,0			
e Ø	5,5	5,5	5,5			
f	8,0	5,5	5,5			
h	46,0	46,0	46,0			
i	50,0	54,0	54,0			
k	-	9,5	9,5			
l	56,0	65,0	72,0			
m	51,0	58,0	64,0			
α	20°	20°	20°			
Leiter mm ² min	1,5	1,5	1,5			
Leiter mm ² max	4	4	4			